



Simply Showers

Fittings for Bathrooms

Simply Showers

Welcome to Simply Showers, which has been devised to simplify the many hundreds of bathroom glass hardware products we offer into a range of popular fittings to cover the majority of day-to-day installations.

Founded over a century ago, Bohle has a long history of supplying glass hardware and fittings for bathrooms, showers and wet rooms.

Simply Showers features several new products, conceived, engineered and manufactured in-house by Bohle, offering unrivalled technical excellence, superior German quality, reliability and superb aesthetics.

Whether you are designing a high end, individual installation, requiring exceptional quality, in a finish to match your client's bespoke colour scheme, or simply needing a high volume of robust, good looking chrome shower hinges for a hotel refurbishment, Bohle has the products you can rely on from a company you can trust.



Contents

Juna Shower Door Hinge	4 – 7
Bilbao Shower Door Hinges	8 – 13
Madrid Shower Door Hinge	14 – 16
Arta Shower Door Hinge	17
Santos Shower Door Hinge	18 – 21
Avila Shower Door Hinge	22
Aqua Shower Door Hinge	23 – 25
MasterTrack® ST	26 – 29
Reinforcement Bars	30 – 31
Stick-on Profiles	32
Thresholds	32
Shower Handles	33
Shower Doorknobs & Towel Handles	34 – 35
Sealing Strip Selector	36
Sealing Strips	37 – 38
U-channel	39
Setting Blocks	40
Shelf Supports	40
Mirror Fixings	41 – 42
XtraMount® Mirror Tape	43
Demisting Pads	43
AquaDrill Pro	44 – 45
BriteGuard Pro®	46
Glass Cleaner & Mirror Adhesive	47

Juna Shower Door Hinge

Modern bathrooms demand contemporary designs and high quality products. The Juna shower door hinge delivers on both counts.

Minimum gap dimensions, no visible screws, and a practically continuous sealing strip emphasize its classy looks. Juna also has an above-average return angle of approximately 20° which closes the glass door automatically.

The high quality components made of brass and stainless steel on the inside of the hinge guarantee a long service life of the product. Tested up to 100,000 cycles to DIN 14428 with a carrying capacity of up to 50kg.

Perfect zero position adjustment

Thanks to the innovative clamping technology, the hinge pin is not damaged by the locking screw. In contrast to standard locking screw adjusting hinges, the innovative technology enables the precise adjustment of the zero position down to the millimetre. Depending on the installation, a sealing profile is therefore not necessarily required.

Product Highlights:

- Easy installation using just one tool
- Patented clamping technology
- Zero point adjustment
- Minimum gap dimensions
- Precise fit for cover caps
- Also available for saunas
- Load capacity 50kg per pair

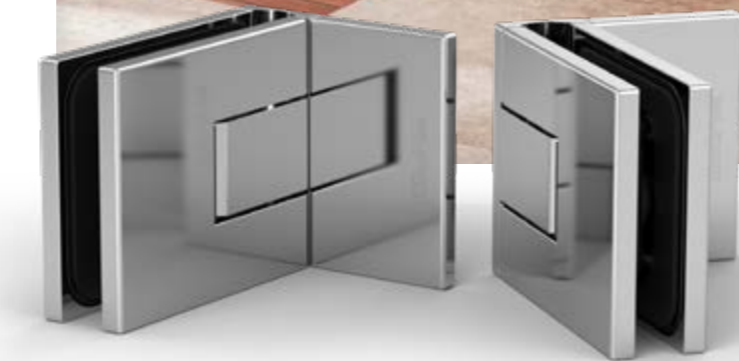

100.000
CYCLES TESTED

5 YEAR
WARRANTY

QUALITY BY BOHLE
MADE IN GERMANY



Juna

Available in a range of colours



Juna Shower Door Hinges

With full cover for 6 - 10 mm, glass/wall, one side wall mounted, 90°. Sales unit per pair.

Art. No.	Max. door weight kg/Finish
BO 5410310	50kg, shiny chrome plated
BO 5410310S	32kg, shiny chrome plated, for sauna
BO 5410311	50kg, stainless steel look
BO 5410311S	32kg, stainless steel look, for sauna
BO 5410312	50kg, black
BO 5410312S	32kg, black, for sauna

With full cover for 6 - 10 mm, glass/glass, 180°. Sales unit per pair.

Art. No.	Max. door weight kg/Finish
BO 5410300	50kg, shiny chrome plated
BO 5410300S	32kg, shiny chrome plated, for sauna
BO 5410301	50kg, stainless steel look
BO 5410301S	32kg, stainless steel look, for sauna
BO 5410302	50kg, black
BO 5410302S	32kg, black, for sauna

With full cover for 6 - 10 mm, glass/glass, 90°, 50kg max. weight per pair. Sales unit per pair.

Art. No.	Finish
BO 5410340	Shiny chrome plated
BO 5410341	Stainless steel look
BO 5410342	Black

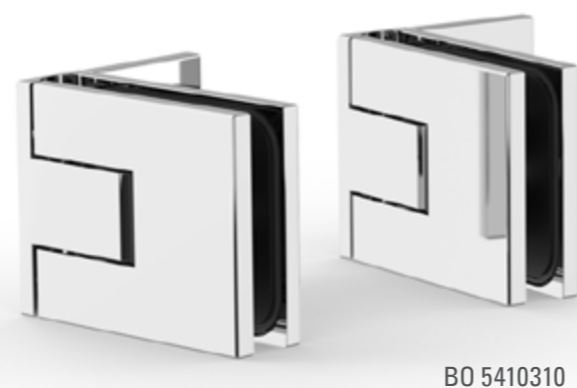

BO 5410310



BO 5410302

With full cover for 6 - 10 mm, glass/glass, 135°, 50 kg max. weight per pair. Sales unit per pair.

Art. No.	Finish
BO 5410344	Shiny chrome plated
BO 5410345	Stainless steel look
BO 5410346	Black

Juna Corner Clamps

With full cover for 6 - 10 mm, 90°. Sales unit per pair.

Art. No.	Description/Finish
BO 5410323	glass/glass, shiny chrome plated
BO 5410324	glass/glass, stainless steel look
BO 5410325	glass/glass, black
BO 5410333	glass/wall, shiny chrome plated
BO 5410334	glass/wall, stainless steel look
BO 5410335	glass/wall, black

With full cover for 6 - 10 mm, glass/glass, 135°. Sales unit per pair.

Art. No.	Finish
BO 5410347	Shiny chrome plated
BO 5410348	Stainless steel look
BO 5410349	Black



BO 5410323



BO 5410325

Watch the Juna video:



Bilbao Premium and Premium HD

The Bilbao range of shower door hinges has something for everyone, from our Basic range for budget-conscious customers to our Premium HD range. All combine a modern square design with useful technical details. Thanks to its versatility and functionality and an appealing price:performance ratio, the Bilbao range is one of our most popular. It is equipped with a self-closing function starting from an opening angle of +/-15°. Outside this range the hinge can stop in any position.

Bilbao Shower Hinge

The Bilbao Premium and Premium HD hinges have an adjustable zero position for easy installation. Inspected according to DIN 14428.

Bilbao Premium shower door hinge, glass/wall, for 8 - 12mm glass, 90°, 40kg max. door weight per pair. Sales unit per pc.

Art. No.	Description/Finish
BO 5211551	Both sides wall mounted, shiny chrome plated
BO 5211552	Both sides wall mounted, stainless steel look
BO 5211553	One side wall mounted, shiny chrome plated
BO 5211553B	One side wall mounted, black
BO 5211554	One side wall mounted, stainless steel look

Bilbao Premium shower door hinge, glass/glass, for 8 - 12mm glass, 180°, 40kg max. door weight per pair. Sales unit per pc.

Art. No.	Finish
BO 5211555	Shiny chrome plated
BO 5211556	Stainless steel look

Bilbao Premium shower door hinge, glass/glass, for 8 - 12mm glass, 90°, 40kg max. door weight per pair. Sales unit per pc.

Art. No.	Finish
BO 5211557	Shiny chrome plated
BO 5211558	Stainless steel look



BO 5211551



BO 5211553B



BO 5211555



Bilbao

Bilbao

Bilbao Premium corner clamp, glass/wall, for 8 - 12mm glass, 90°, Sales unit per pc.

Art. No.	Finish
BO 5211569N	Shiny chrome plated
BO 5211570N	Stainless steel look



BO 5211569N



BO 5211561

Bilbao Premium HD

Bilbao Premium shower door hinge, glass/wall, for 8 - 12mm glass, 90°, 50kg max. door weight per pair. Sales unit per pc.

Art. No.	Description/Finish
BO 5211561	Both sides wall mounted, shiny chrome plated
BO 5211562	Both sides wall mounted, stainless steel look
BO 5211563	One side wall mounted, shiny chrome plated
BO 5211564	One side wall mounted, stainless steel look

Bilbao Premium HD shower door hinge, glass/glass, for 8 - 12mm glass, 180°, 50kg max. door weight per pair. Sales unit per pc.

Art. No.	Finish
BO 5211565	Shiny chrome plated
BO 5211566	Stainless steel look



BO 5211566



BO 5211564

Bilbao Premium HD corner clamp, glass/wall, for 8 - 12mm glass, 90°, Sales unit per pc.

Art. No.	Finish
BO 5211567N	Shiny chrome plated
BO 5211568N	Stainless steel look



BO 5211568N



BO 5211567N



Bilbao Select

In addition to all the usual Bilbao features, Bilbao Select has an adjustable zero position, making the alignment of the door much easier.

Bilbao Select

Bilbao Select shower door hinge, glass/wall, for 8 - 12mm glass, 90°, 40kg max. door weight per pair. Sales unit per pc.

Art. No.	Description/Finish
BO 5211516	Both sides wall mounted, shiny chrome plated
BO 5211517	Both sides wall mounted, stainless steel look
BO 5211546	One side wall mounted, shiny chrome plated
BO 5211546B	One side wall mounted, black
BO 5211547	One side wall mounted, stainless steel look



BO 5211516



BO 5211546B

Bilbao Select shower door hinge, glass/glass, for 8 -12mm glass, 40kg max. door weight per pair. Sales unit per pc.

Art. No.	Description/Finish
BO 5211716	180°, shiny chrome plated
BO 5211716B	180°, black
BO 5211717	180°, stainless steel look
BO 5211806	90°, shiny chrome plated
BO 5211906	135°, shiny chrome plated



BO 5211716B

BO 5211717

Bilbao Select corner clamp, for 8 - 12mm glass, 90°. Sales unit per pc.

Art. No.	Description/Finish
BO 5213140	Glass/wall, shiny chrome plated
BO 5213142B	Glass/wall, black
BO 5213150	Glass/glass, shiny chrome plated
BO 5213151	Glass/glass, stainless steel look
BO 5213152B	Glass/glass, black



BO 5213140

BO 5213151

Bilbao Basic

Bilbao Basic corner clamp, for 8 – 12mm glass, 90°. Sales unit per pc.

Art. No.	Description/Finish
BO 5213142	Glass/wall, shiny chrome plated
BO 5213143	Glass/wall, stainless steel look
BO 5213152	Glass/glass, shiny chrome plated
BO 5213153	Glass/glass, stainless steel look



BO 5213142B

Bilbao Basic shower door hinge, glass/wall, for 8 - 12mm glass, 90°, 36kg max. door weight per pair. Sales unit per pc.

Art. No.	Description/Finish
BO 5218010	Both sides wall mounted, shiny chrome plated
BO 5211550	One side wall mounted, stainless steel look
BO 5211549	One side wall mounted, shiny chrome plated



BO 5218010

Bilbao Basic shower door hinge, glass/glass, for 8 – 12mm glass, 180°, 36kg max. door weight per pair. Sales unit per pc.

Art. No.	Finish
BO 5218210	Shiny chrome plated
BO 5218211	Stainless steel look



BO 5218211

Bilbao Basic connectors. Sales unit per pc.

Art. No.	Description/Finish
BO 5213162	For 8 – 12mm glass, glass/glass, 180°, shiny chrome plated
BO 5213163	For 8 – 12mm glass, glass/glass, 180°, stainless steel look

Bilbao Shower Hinge Comparison Table

Bilbao Shower Door Hinges	Bilbao Basic	Bilbao Select	Bilbao Premium	Bilbao Premium HD
Adjustable zero position	–	✓	✓	✓
Glass cut-out	✓	✓	✓	✓
Glass thickness (mm)	8 / 10 / 12	8 / 10 / 12	8 / 10 / 12	8 / 10 / 12
Max. weight (kg)	36	40	40	50
Max. door height (mm)	2000	2000	2000	2000
Max. door width (mm)	900	1000	1000	1000

Madrid



The Madrid shower door fittings are the elegant solution for shower doors. The hinges are designed for one side opening doors and enable the sealing strips to be directly guided through the hinge. No unsightly screw fittings are visible on the classic square design. In order to avoid the incorrect operation of the door (opening against the opening direction), sealing strips and, if necessary, a stop should be used. The door is kept closed by magnetic seals.



BO 5215430H



BO 5215483



BO 5218460

Madrid

Madrid shower door hinge, glass/wall, for 6 – 10mm glass, 90°. Sales unit per pc.

Art. No.	Description/Finish
BO 5215430H	Opens out, shiny chrome plated
BO 5215431	Opens inwards, shiny chrome plated
BO 5215482	Opens inwards, stainless steel look
BO 5215483	Opens inwards, black
BO 5215485	Opens out, stainless steel look
BO 5215484	Opens out, black

Madrid angle connector, glass-glass/wall, 45 – 180°

UNIQUE design

Art. No.	Description
BO 5218459	Shiny chrome plated
BO 5218460	Stainless steel look
BO 5218461	Black



Madrid

Madrid corner clamps, for 6 – 10mm glass, 90°. Sales unit per pc.

Art. No.	Description/Finish
BO 5215433	Glass/wall, shiny chrome plated
BO 5215434	Glass/glass, shiny chrome plated
BO 5215486	Glass/glass, black
BO 5215487	Glass/glass, stainless steel look
BO 5215488	Glass/wall, stainless steel look
BO 5215489	Glass/wall, black



Madrid shower door hinge, glass/glass, for 6 – 10mm glass, 135° - 180°. Sales unit per pc.

Art. No.	Finish
BO 5215490	Shiny chrome plated
BO 5215491	Stainless steel look
BO 5215492	Black



Madrid Shower Door Hinge, glass/wall, for 6 – 10 mm glass, 180°. Sales unit per pc.

Art. No.	Finish
BO 5215496	Shiny chrome plated
BO 5215497	Stainless steel look
BO 5215498	Black



Madrid side clamp, glass/glass/wall, for 6 – 10mm glass, 180°. Sales unit per pc.

Art. No.	Finish
BO 5215493	Shiny chrome plated
BO 5215494	Stainless steel look
BO 5215495	Black



Arta

Arta Shower Door Hinge

The Arta shower door hinge is now available with rise and fall mechanism and adjustable zero position. The wall mounting hinge combines these functions with the proven chamfer. A screw located underneath the hinge enables adjusting the zero position which is loosened after installing the glass. The entire mechanism can then be rotated by moving the pane aided by the glass weight, enabling the position of the glass to be adjusted quickly and easily. The rise and fall mechanism enables closing the shower door automatically and also includes an opening position of approx. 90°.



Arta rise and fall shower hinge, glass/wall, for 6 – 10mm glass, 90°. Sales unit per pc.

Art. No.	Side/Finish
BO 5215530L	Left, shiny chrome plated
BO 5215530R	Right, shiny chrome plated
BO 5215670L	Left, stainless steel look
BO 5215670R	Right, stainless steel look
BO 5215671L	Left, black
BO 5215671R	Right, black



Arta rise and fall shower hinge, glass/glass, for 6 – 10mm glass, 180°. Sales unit per pc.

Art. No.	Side/Finish
BO 5215532L	Left, shiny chrome plated
BO 5215532R	Right, shiny chrome plated
BO 5215672L	Left, stainless steel look
BO 5215672R	Right, stainless steel look
BO 5215673L	Left, black
BO 521564R	Right, black



Santos



The new Santos shower door hinge displays proven quality in a new design. This new look is both modern and elegant. Due to the combination of round and square elements, the system is suitable for a wide range of fittings. Not only are the screws concealed behind cover caps, but the zero position adjustment is completely invisible. Smallest gap dimensions with clear-cut lines reduce water leakage to a minimum. This all-round product turns Santos into a high-quality shower door hinge.

DESIGNED BY BOHLE

Santos

Santos shower door hinge with full cover, for 8 – 10mm glass, 90°, 50kg max door weight per pair. Sales unit per pair.

Art. No.	Description/Finish
BO 5218442	Glass/glass, shiny chrome plated
BO 5218451	Glass/glass, stainless steel look
BO 5218453	Glass/glass, black
BO 5218434	Glass/wall, shiny chrome plated
BO 5218434B	Glass/wall, black
BO 5218452	Glass/wall, stainless steel look

Santos side clamp, straight shaped, glass/wall, 90°. Sales unit per pair.

Art. No.	Finish
BO 5218468	Shiny chrome plated
BO 5218469	Stainless steel look
BO 5218470	Black



BO 5218442



BO 5218434B



BO 5218468



Santos

Santos

Santos corner clamp with full cover, for 8 - 10mm glass, 90°. Sales unit per pair.

Art. No.	Description/Finish
BO 5218432	Glass/glass, shiny chrome plated
BO 5218455	Glass/glass, stainless steel look
BO 5218474	Glass/glass, black
BO 5218435	Glass/wall, shiny chrome plated
BO 5218454	Glass/wall, stainless steel look
BO 5218435B	Glass/wall, black



BO 5218435

Santos shower door hinge with full cover, glass/glass, for 8 - 10mm glass, 135°, 50kg max. door weight per pair. Sales unit per pair.

Art. No.	Finish
BO 5218445	Black
BO 5218446	Stainless steel look
BO 5218450	Shiny chrome plated



BO 5218446

Santos corner clamp with full cover, glass/glass, for 8 - 10 mm glass, 135°. Sales unit per pair.

Art. No.	Finish
BO 5218447	Shiny chrome plated
BO 5218448	Stainless steel look
BO 5218449	Black



BO 5218448

Santos shower door hinge with full cover, for 8 – 10mm glass, 180°, 50kg max. door weight per pair. Sales unit per pair.

Art. No.	Description/Finish
BO 5218433	Glass/glass, shiny chrome plated
BO 5218433B	Glass/glass, black
BO 5218456	Glass/glass, stainless steel look
BO 5218471	Glass/wall, shiny chrome plated
BO 5218472	Glass/wall, stainless steel look
BO 5218473	Glass/wall, black



BO 5218471

BO 5218433B

Santos side clamp with full cover, for 8 – 10mm glass, glass/glass/wall, 180°. Sales unit per pair.

Art. No.	Finish
BO 5218465	Stainless steel look
BO 5218466	Black
BO 5218467	Shiny chrome plated



BO 5218472

Santos corner clamp adjustable, glass/glass, glass/wall, 45 - 180°, also for Madrid and Arta shower ranges. Sales unit per pc.

Art. No.	Finish
BO 5218459	Shiny chrome plated
BO 5218460	Stainless steel look
BO 5218461	Black



BO 5218460

Santos corner clamp adjustable, flush mounted, glass/glass, glass/wall, 45 - 180°, also for Madrid and Arta shower ranges. Sales unit per pc.

Art. No.	Finish
BO 5218462	Shiny chrome plated
BO 5218463	Stainless steel look
BO 5218464	Black



BO 5218462

Avila

Avila Shower Door Hinge

The Avila shower door hinges for one-side opening doors are not only suited to glass thickness of 6, 8, and 10 mm but can also be used for doors with a height of up to 2.25 m, which are especially sought-after in modern bathrooms.

The bathroom is increasingly becoming a place of well-being where ample space is reserved for the shower. High quality materials ensure a long service life.



BO 5215470

Avila

Avila door hinge with stop, glass/wall, for 6 – 10mm glass, 90°. Sales unit per pc.

Art. No.	Description/Finish
BO 5215470	Opens outwards, shiny chrome plated
BO 5215471	Opens inwards, shiny chrome plated

Avila shower door hinge with stop, glass/glass, for 6 – 10mm glass, 180°. Sales unit per pc.

Art. No.	Finish
BO 5215474	Shiny chrome plated

Avila corner clamp, for 6 – 10mm glass, 90°

Art. No.	Description/Finish
BO 5215472	Glass/glass, shiny chrome plated
BO 5215473	Glass/wall, shiny chrome plated



Aqua Light

Aqua light

Bohle Aqua shower door hinges offer an alternative to a conventional shower door hinge. The full length aluminium profile system combines elegant design with impressive functionality: an infinitely adjustable zero position, a raising/lowering mechanism as well as vertical adjustment. No glass processing required.

Aqua light Shower Door Hinge

Aqua light shower door hinge complete set, glass/wall, for 8mm glass, length 2200mm, 90°, max. door weight per pair 37kg. Sales unit per pc.

Art. No.	Finish
BO 5200419	Aluminium EV1
BO 5200420	Polished aluminium
BO 5200421B	Black



BO 5200421B

Aqua Shower Door Hinge

Aqua shower door hinge complete set, glass/wall, length 2200mm, 90°, max. door weight per pair 37kg. Sales unit per pc.

Art. No.	Description/Finish
BO 5200405	For 6mm glass, aluminium EV1
BO 5200406	For 6mm glass, polished aluminium
BO 5200407	For 8mm glass, aluminium EV1
BO 5200408	For 8mm glass, polished aluminium



BO 5200407



Aqua

Aqua supplementary profile for wall connection for 6mm fixed sidelight, 2200mm. Sales unit per pc.

Art. No.	Finish
BO 5200409	Aluminium EV1
BO 5200410	Polished aluminium

Aqua middle profile for wall connection for 8mm fixed sidelight, 2200mm. Sales unit per pc.

Art. No.	Finish
BO 5200411	Aluminium EV1
BO 5200412	Polished aluminium

Aqua wall connecting profile for 8mm fixed sidelight, 2200mm. Sales unit per pc.

Art. No.	Finish
BO 5200413	Aluminium EV1
BO 5200414	Polished aluminium



BO 5200411

Accessories

Art. No.	Description/Finish
BO 5200415	Aqua rubber profile for wall connecting profiles BO 5200413 and BO 5200414
BO 5200416	Aqua supplementary set, fixed sidelight for BO 5200407, per set
BO 5200417	Aqua supplementary set, fixed sidelight for BO 5200408, per set

MasterTrack® ST

Smooth-running sliding doors

Bohle's MasterTrack® FT technology for internal sliding doors has now been applied to shower installations. MasterTrack® ST combines a modern design with easy installation. The system can be installed to recessed and corner showers, as well as detached showers. It comes as a barrier-free option, or with an unobtrusive threshold, where space is limited or for showers up to 2m wide.

High-quality ball bearings ensure a smooth and soft running. Its slim profile comes in aluminium coloured or polished anodised.



At a glance:

- Maximum performance, elegant design
- Impressive running smoothness with high quality damping system
- No glass processing required
- Easy installation: It can be adjusted from the front
- Height adjustable by +/- 3mm



[Download the brochure](#)



MasterTrack® ST

MasterTrack® ST

MasterTrack ST® double door corner application, 1000mm x 1000mm. Sales unit per set.

Art. No.	Description/Finish
BO 5741051	Aluminium anodised E6/C0
BO 5741052	Black
BO 5741053	Aluminium polished E8/C0



BO 5741052

MasterTrack ST® recess application. Sales unit per set.

Art. No.	Length/Finish
BO 5741541	1200mm, aluminium anodised E6/C0
BO 5741542	1200mm, black
BO 5741543	1200mm, aluminium polished E8/C0
BO 5742041	2000mm, aluminium anodised E6/C0
BO 5742042	2000mm, black
BO 5742043	2000mm, aluminium polished E8/C0



BO 5741541

MasterTrack ST® profile set.

Art. No.	Length/Finish
BO 5700040	1200mm, aluminium anodised E6/C0
BO 5700041	1200mm, aluminium polished E8/C0
BO 5700042	2000mm, aluminium anodised E6/C0
BO 5700043	2000mm, aluminium polished E8/C0
BO 5700059	1200mm, black
BO 5700060	2000mm, black



BO 5700040



BO 5700044

MasterTrack ST® wall mounting kit. Sales unit per set.

Art. No.	Description/Finish
BO 5700044	Wall mounting
BO 5700045	Glass, aluminium anodised E6/C0
BO 5700046	Glass, aluminium polished, E8/C0
BO 5700061	Glass, black



BO 5700045

MasterTrack ST® corner connectors for running track. Sales unit per pc.

Art. No.	Description/Finish
BO 5700047	Aluminium anodised E6/C0
BO 5700048	Aluminium polished E8/C0
BO 5700062	Black



BO 5700047

MasterTrack ST® corner connector for threshold. Sales unit per pc.

Art. No.	Description/Finish
BO 5700054	Aluminium anodised E6/C0
BO 5700055	Aluminium polished E8/C0
BO 5700064	Black

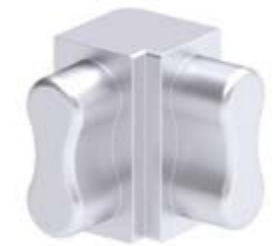

BO 5700055

MasterTrack ST® threshold, 20 x 10mm, length 1000mm. Sales unit per pc.

Art. No.	Description/Finish
BO 5700052	Aluminium anodised E6/C0
BO 5700053	Aluminium polished E8/C0
BO 5700063	Black



BO 5700053

MasterTrack ST® floor guide. Sales unit per set.

Art. No.	Description/Finish
BO 5700056	Aluminium anodised E6/C0
BO 5700057	Aluminium polished E8/C0
BO 5700065	Black



BO 5700056

Other MasterTrack ST® Products

Art. No.	Description	Unit
BO 5700049	Carriages	Set
BO 5700050	Stopper for use without damper	Set
BO 5700051	Damper	Pc
BO 5700058	Glazing blocks accessory set	Set



BO 5700049

BO 5700051

Reinforcement Bars



BO 5420165

With Bohle reinforcement bars, you will find the perfect mix of form and function. The variety within this range enables almost any type of construction project. Easy to mount.



Reinforcement Bar

Art. No.	Description
BO 5420262	Square, glass/wall, 8 – 10mm glass, shiny chrome plated, length 1210mm
BO 5420262B	Square, glass/wall, 8 – 10mm glass, black, length 1210mm
BO 5420110	Square, glass/wall, 8 – 10mm glass, stainless steel look, length 1210mm
BO 5420165B	Reinforcement bar set, round, glass/wall, 12Ø, for 8 – 10mm glass, black*
BO 5420165	Reinforcement bar set, round, glass/wall, 12Ø, for 8 – 10mm glass, shiny chrome plated*
BO 5420209	Reinforcement bar set, round, glass/wall, 12Ø, for 8 – 10mm glass, stainless steel look*

* All lengths 1210mm

Bohle has a wide range of glass and corner connectors to suit all installations, and in a range of colours.

A selection of products is listed below but for the full range visit the website or scan the QR code:



Sample colours of Bohle reinforcement bars



BO 5420208

BO 5420240

Reinforcement Bars

Sales unit per pc.

Art. No.	Description
BO 5420240	Reinforcement bar set, square 15mm, glass-wall 90°, stainless steel look matt, 1000mm
BO 5420241	Reinforcement bar set, square 15mm, glass-wall 90°, stainless steel look shiny, 1000mm
BO 5420237	Reinforcement bar set, square, glass-glass, polished stainless steel look shiny, 1000mm
BO 5420238	Reinforcement bar set, square, glass-wall, 45°, stainless steel look matt, 500mm
BO 5420239	Reinforcement bar set, square, glass-wall, 45°, stainless steel look shiny, 500mm
BO 5420211	Telescopic reinforcement bar set, round 19 Ø, glass-wall 90°, 820 – 1000mm, shiny chrome plated
BO 5420215	Telescopic reinforcement bar set, round 19 Ø, glass-wall 90°, 1000 – 1150mm, shiny chrome plated
BO 5420221	Telescopic reinforcement bar set, round 19 Ø, glass-wall, 45°, 240 – 400mm, shiny chrome plated
BO 5420225	Telescopic reinforcement bar set, round 19 Ø, glass-wall, 45°, 550 – 700mm, shiny chrome plated
BO 5420231	Telescopic reinforcement bar set, round 19 Ø, glass-glass, shiny chrome plated, 750 – 1050mm
BO 5420267	Reinforcement bar set, round 19 Ø, glass-wall 90°, shiny chrome plated, 1300mm
BO 5420208	Reinforcement bar set, round 19 Ø, glass-wall 45°, shiny chrome plated, 1000mm

Stick-on Profiles

For room dividers that achieve a modern industrial look, characterised by its black metallic elements, we recommend adding decorative profile. They are bonded between existing profiles, enable the visual division of large glass surfaces and set strong accents. These are self-adhesive and can be cut to size. Quick and easy shortening.



Art. No.	Description
BO 5220850	Black RAL 9005, powder coated, material aluminium, satin finish, length 2800mm

Thresholds

Available in different sizes – please contact us for advice.
Non self-adhesive. Threshold must be fixed individually and on-site.

Art. No.	Description	Unit
BK 6907031	Threshold, shiny silver colour, length 1800mm	Pc
BK 6907082	Threshold, white powder coated RAL 9010, length 1800mm	Pc
BK 69080	Threshold, acrylic, 20 x 10mm, length 1000mm	Pc
BO 5281000	End caps, set, left and right, 90° corner, aluminium, chrome	Set
BO 5281001	End caps, set, left and right, 90° corner, aluminium, white	Set
BK 69081	Threshold, acrylic, 20 x 10mm, length 2000mm	Pc
BK 69130	Threshold, acrylic, 10 x 5mm, length 1000mm	Pc
BK 69131	Threshold, acrylic, 10 x 5mm, length 2000mm	Pc



Shower Handles

Our wide range of shower handles helps to create a shower unit based on personal taste and the style of the bathroom overall. We offer a variety of materials, shapes and finishes, all with the great quality expected from a Bohle product.



Shower Handles

Shower door handles for 4 – 12mm glass. Sales unit per set.

Art. No.	Description
BO 5212510	Tube 19 mm Ø, stainless steel, brushed, c/c 152 mm, drill hole 12 mm Ø
BO 5212511	Tube 19 mm Ø, stainless steel, polished, c/c 152 mm, drill hole 12 mm Ø
BO 5212514	Tube 19 mm Ø, stainless steel, brushed, c/c 203 mm, drill hole 12 mm Ø
BO 5212515	Tube 19 mm Ø, stainless steel, polished, c/c 203 mm, drill hole 12 mm Ø
BO 5212520	19 x 19 mm, stainless steel, brushed, c/c 152 mm, drill hole 10 mm Ø
BO 5212521	19 x 19 mm, stainless steel, polished, c/c 152 mm, drill hole 10 mm Ø
BO 5212524	19 x 19 mm, stainless steel, brushed, c/c 203 mm, drill hole 10 mm Ø
BO 5212525	19 x 19 mm, stainless steel, polished, c/c 203 mm, drill hole 10 mm Ø
BO 5212524B	19 x 19 mm, black, powder coated, c/c 203 mm drill hole 10 mm Ø

Shower Doorknobs & Towel Handles



BO 5213718



BO 5213705B



BO 5213706



BO 5206702

Shower doorknobs for 6 – 10mm glass. Sales unit per set.

Art. No.	Description
BO 5206700	35 mm Ø, zinc, shiny chrome plated, double-sided
BO 5206702	35 mm Ø, brass, shiny chrome plated, double-sided
BO 5213733	30 mm Ø, brass, shiny chrome plated, double sided
BO 5213700	40 mm Ø, brass, stainless steel look, double-sided, drill hole 16 mm Ø
BO 5213701	40 mm Ø, brass, shiny chrome plated, double-sided, drill hole 16 mm Ø
BO 5213702	40 mm Ø, brass, matt chrome plated, double-sided, drill hole 16 mm Ø
BO 5213705	32 mm Ø, brass, chrome plated, double sided, drill hole 10mm Ø
BO 5213705B	32 mm Ø, black, double sided, drill hole 10mm Ø
BO 5213706	32 mm Ø, brass, stainless steel look, double sided, drill hole 10mm Ø
BO 5213722	30 mm Ø, brass, chrome finish, double-sided, drill hole 10 mm Ø
BO 5213717	45 mm Ø, stainless steel, brushed, double-sided
BO 5213718	45 mm Ø, stainless steel, polished, double-sided
BO 5213719	45 mm Ø, aluminium, black anodized E6/C35, double-sided
BO 5213781	Crystal glass, Ø 37mmx 31mm, box of 1 set, drill hole 12mm Ø
BO 5215020	For saunas, wood, double-sided 65 mm Ø, for 8 mm glass, drill hole 16 mm Ø

Shower doorknobs, square, for 6 – 12mm glass. Sales unit per set.

Art. No.	Description
BO 5206711	30 x 30 mm, brass, shiny chrome-plated
BO 5206711B	30 x 30 mm, brass, black
BO 5206713	30 x 30 mm, brass, polished stainless steel look
BO 5206717	30 x 70 mm, brass, shiny chrome-plated



BO 5206717



BO 5206711



BO 5215024

Shower towel handles for 6 – 12mm glass, polished stainless steel look. Sales unit per set.

Art. No.	Description
BO 5215024	With interior knob, c/c 375mm, drill hole 14 mm Ø
BO 5215025	With interior knob, c/c 400mm, drill hole 12mm Ø
BO 5215026	With interior knob, c/c 475mm, drill hole 14mm Ø
BO 5215034	Handle/towel rack, c/c 457 mm, drill hole 12mm Ø
BO 5215035	Handle/towel rack, c/c 610 mm, drill hole 12mm Ø

Juna doorknobs are available in a range of colours.



Sealing Strip Selector

For shower hinges with a 7-8mm glass-wall gap

Sealing Strips

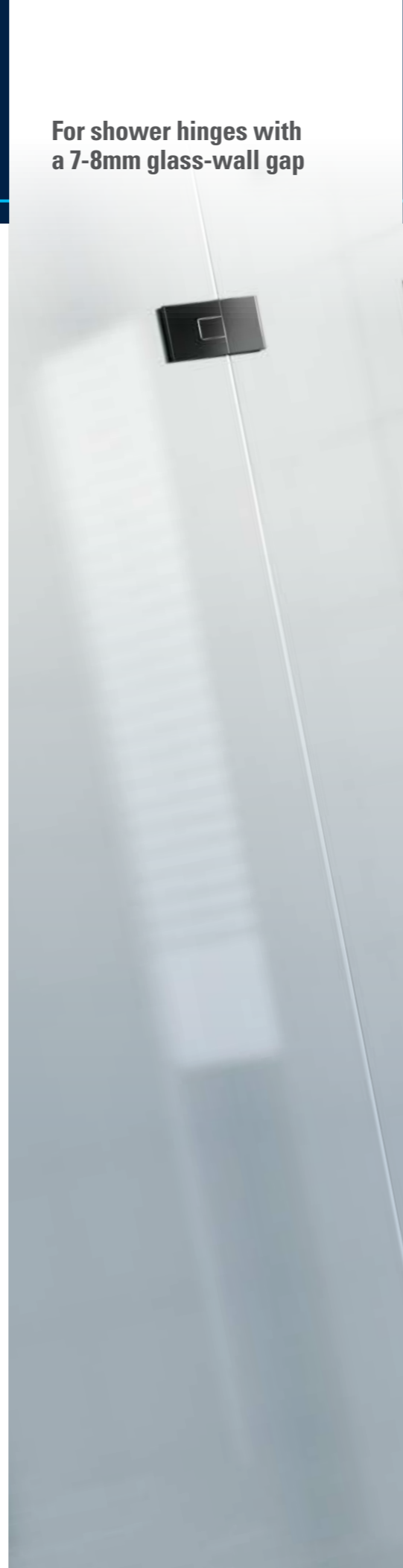
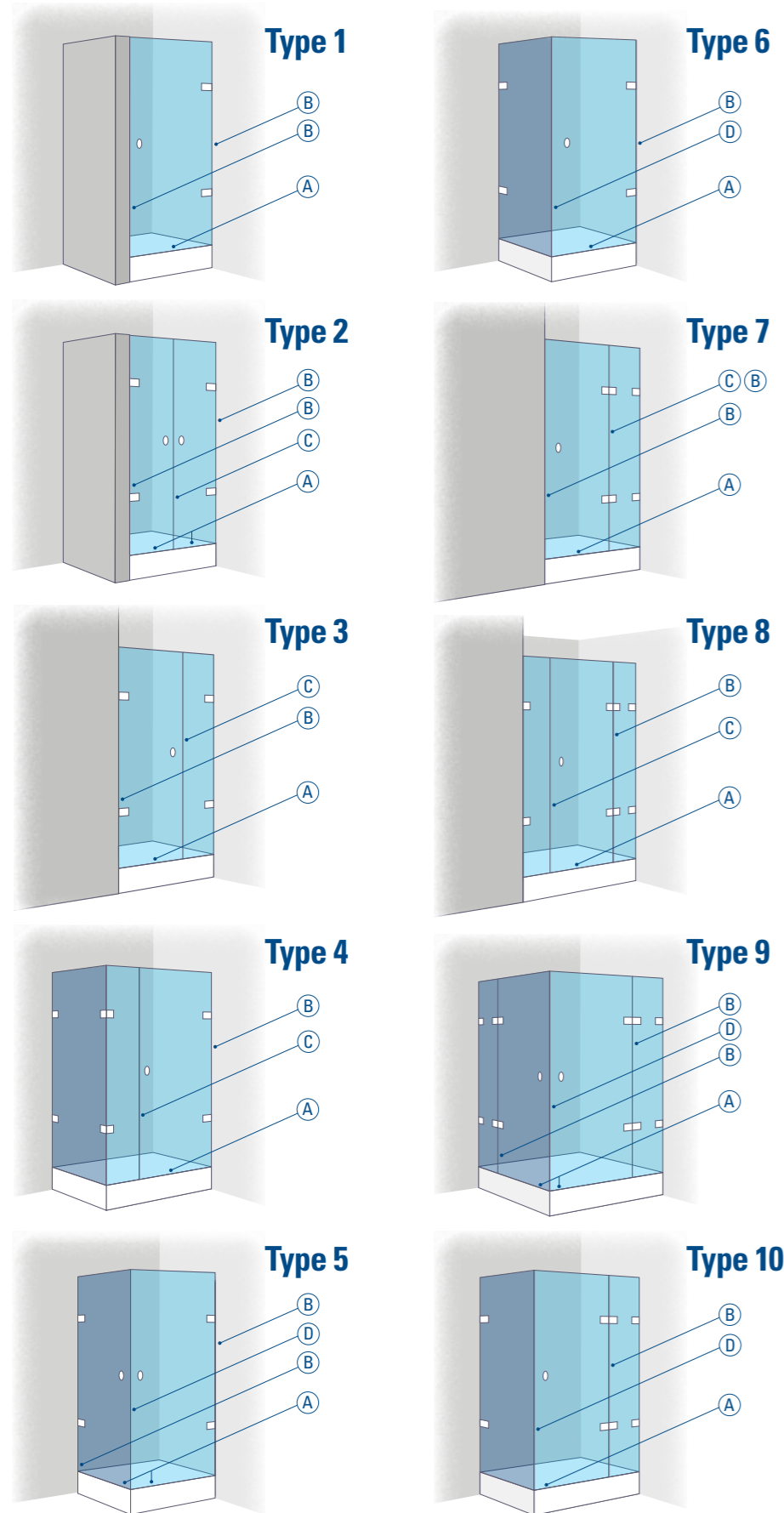

Sealing strips for 6 + 8mm glass

Art. No.	Description	Type	Unit
BO 5213516	Shower door seal with lower sealing lip, length 2160mm	A, B	Pc
BO 5213517	With bellows, length 2160mm	B	Pc
BO 5213518	To seal between side panel and door, 180°, length 2160mm	C	Pc
BO 5213519	To seal between side panel and door, 90°, length 2160mm	D	Pc
BO 5213490	With lower sealing lip & water deflector, length 2160mm	A	Pc
BO 5281035	With magnet for 90° swinging doors, length 2000mm	D	Pair
BO 5281036	With magnet for 90° swinging doors, length 2500mm	D	Pair
BK 69310	With magnetic profile, glass/glass, 180°, length 2010mm	C	Pair
BK 69311	With magnetic profile, glass/glass, 180°, length 2500mm	C	Pair
BO 5213515	With magnetic profile, 135°, length 2160mm	C	Pair
BO 5213529	With magnetic profile for corner entry, length 2160mm	D	Pair
BO 5213530	With magnetic profile, 180°, length 2160mm	C	Pair
BO 5213491	With water deflector, without lower sealing lip, length 2160mm	B	Pc
BO 5213494	Bottom sealing strip with bulb seal, length 2010mm	A	Pc
BO 5281095	With sealing lip, 2500mm	A	Pc
BO 5213493	With water deflector, length 2160mm	A	Pc
BO 5281094	With long water deflector, length 2010mm	A	Pc

Sealing strips for 8mm glass. Sales unit per pc.

Art. No.	Description	Type
BO 5281021	With bellows, length 2000mm	B, C
BO 5213492	With lip to seal between glass edge and wall, length 2160mm	B, C

Sealing strips for 8 + 10mm glass. Sales unit per pc.

Art. No.		Type
BO 5281018	To seal between side panel and door, 180°, length 2160mm	C
BO 5281019	To seal between side panel and door, 90°, length 2160mm	D

Sealing strips for 8 - 12mm glass

Art. No.		Type	Unit
BO 5200336	Self-adhesive, transparent, 16mm sealing lips, length 2500mm	A	Pc
BO 5200335	Self-adhesive, transparent, 13mm sealing lips, length 2500mm	A	Pc
BK 69230	Self-adhesive, transparent, length 2500mm	B, C	Pc
BK 69240	Self-adhesive seal with lower bellows, length 2500mm	A	Pc
BK 69250	Magnetic, 90°, self-adhesive, transparent, length 2500mm	D	Pair
BK 69260	Magnetic, 180°, self-adhesive, transparent, length 2500mm	C	Pair

Sealing strip for 10mm glass. Sales unit per pc.

Art. No.		Type
BO 5281092	With lower lip to seal between glass edge & wall, length 2160mm	B, C

Sealing strips for 10 + 12 mm glass

Art. No.		Type	Unit
BO 5281020	With bellows, length 2160mm	B, C	Pc
BO 5281091	With lower lip and water deflector, length 2160mm	A	Pc
BO 5281016	Magnetic, 135°, length 2160mm	C, D	Pair
BO 5281031	Magnetic, for corner entry, 90°, length 2160mm	D	Pair
BO 5281032	Magnetic, 180°, length 2160mm	C	Pair
BO 5281093	With water deflector, length 2160mm	A	Pc

U-channel

As always, you can rely on quality and workmanship in all our u-channel products. All profiles are sturdy and suitable for use in humid environments. Available in a choice of finishes to suit all styles.

U-channel

All sales units per pc.

Art. No.	Description
BO 6703424	20 x 15 x 20 x 1.5 mm, aluminium polished anodised E3/EV1, length 2150 mm
BO 6703429	20 x 15 x 20 x 1.5 mm, aluminium anodised E6/EV1, length 2500 mm
BO 6703430	20 x 13 x 20 x 1.5 mm, aluminium polished anodised E3/EV1, length 2500mm
BO 6703431	20 x 15 x 20 x 1.5 mm, aluminium polished anodised E3/EV1, length 2500 mm
BO 6703432	20 x 15 x 20 x 1.5 mm, stainless steel look brushed E4/C31, length 2500 mm
BO 6703433	20 x 17 x 20 x 1.5 mm, aluminium polished anodised E3/EV1, length 2500 mm
BO 6703434	20 x 17 x 20 x 1.5 mm, aluminium anodised E6/EV1, length 2500 mm
BO 6703435	20 x 17 x 20 x 1.5 mm, stainless steel look brushed E4/C31, length 2500 mm
BO 6703444	20 x 17 x 20 x 1.5 mm, aluminium polished anodised E3/EV1, length 2150 mm
BO 6703464B	20 x 13 x 20 x 1.5 mm, aluminium black anodized E6/C35, length 2500mm
BO 6703412	20 x 13 x 20 x 1.5 mm, aluminium polished anodised E3/EV1, length 2150 mm
BO 6703418	20 x 13 x 20 x 1.5 mm, aluminium anodised E6/EV1, length 2500 mm
BO 6703419	20 x 13 x 20 x 1.5 mm, stainless steel look brushed E4/C31, length 2500 mm

Cover and end caps for u-channel. Sales unit per set.

Art. No.	Description
BO 6703461	Cover cap set for U-profile, 20 x 13 x 20 mm, plastic, silver colour, 10 pieces
BO 6703462	Cover cap set for U-profile, 20 x 15 x 20 mm, plastic, silver colour, 10 pieces

BO 6703419

BO 6703424

BO 6703464B

BO 6703429



Setting Blocks

Transparent Setting Blocks

Sales unit 100 pieces

Art. No.	Description
BO 5121001	1mm
BO 5121002	2mm
BO 5121003	3mm
BO 5121004	4mm
BO 5121005	5mm
BO 5121006	6mm
BO 5121008	8mm
BO 5121010	10mm
BO 5121011	Complete set, 1 – 10mm, 200 pieces



Mirror Fixings

Bohle offers a large selection of custom-fit glazing and mirror profiles for the protection for both interior and exterior use. As always, you can rely on high quality and supreme workmanship. All profiles are sturdy and suitable for use in humid environments, and easy to install.

Mirror Fixings

Art. No.	Description
BO 5208001	Mirror profile, aluminium colour E6
BO 5208005	Mirror profile, stainless steel look
BO 6703450	J mirror profile
BO 6703456	L mirror profile
BO 5201517	L mirror profile
BO 6703459	H mirror profile
BO 5208025	Clip-on mirror profile
BO 5208030	End caps, silver colour
BO 5208031	End caps, stainless steel look
BO 5208016	Concealed mirror rail
BO 60GDX60S	Mirror edge, J section
BO 60GDX61S	Mirror edge, edge angle section
BO 60GDX62S	Mirror edge, end cap
BO 60GDX63S	Mirror edge, T profile



Shelf Supports

Shelf Supports

Art. No.	Description
BO 5207331	Glass-wood shelf support, angular
BO 5206965	Glass-wood shelf support, oval



Safeclix® and Safemax®

Safeclix® and Safemax® supply mirror plates and fixing accessories ready-packed in a set. Mirrors are mounted so that the fixings are invisible to the user, but the mirror can be removed at any time.

The Xtramount® adhesive tape used is high quality and durable. No special installation tools are required. Without visible fixings, elegant mirrors are shown to their best advantage.

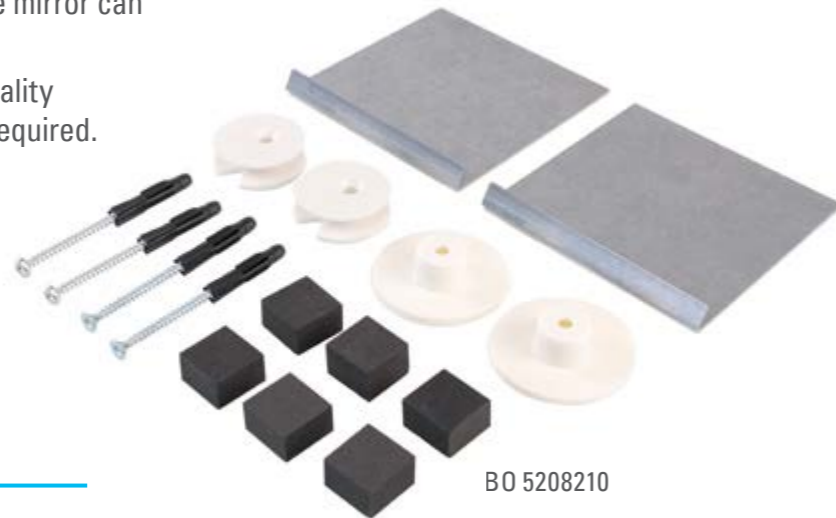

BO 5208210

Safeclix® and Safemax®

Art. No.	Description
BO 5208211	Safeclix® mounting set, load capacity 24kg
BO 5208210	Safeclix® mounting set, load capacity 12kg
BO 5208230	Safemax® mounting set, load capacity 24kg
BP 5208228	Safemax® mounting set, load capacity 12kg
BO 5208220	Safefix® mounting set, load capacity 12kg

Domehead Screws

Steel screws complete with decorative polished chrome domehead covers. The screws are available in various lengths.



BO 6003214

Art. No.	Description
BO 6003214 – 20	Domehead Screws

XtraMount® & Demisting Pads

XtraMount® Mirror Tape

With XtraMount®, mirrors can be fixed quickly and permanently, even in the bathroom. It has good initial adhesion and high final strength and is resistant to ageing. XtraMount® offers high quality for a long-lasting bond.



BO 5207746

There are 9 different variations available in different widths, lengths and thicknesses, depending on the requirement.

All options are available here:



Demisting Pads

To prevent steamed up bathroom mirrors, these demisting pads are self-adhesive and fit to the back of the mirror. Electric conductors in the film heat the mirror to approx. 30°C therefore preventing condensation on the mirror. Fully approved to BS and international standards by BEAB and other recognised test houses.

Visabel heated mirror pads, 5 amp, sales unit per pc

Art. No.	Description
BO 60GNX30	150 x 274 mm, 6.25 w
BO 60GNX31	274 x 274 mm, 12.5 w
BO 60GNX32	274 x 574 mm, 25 w
BO 60GNX33	524 x 524 mm, 50 w
BO 60GNX34	524 x 1024 mm, 100 w

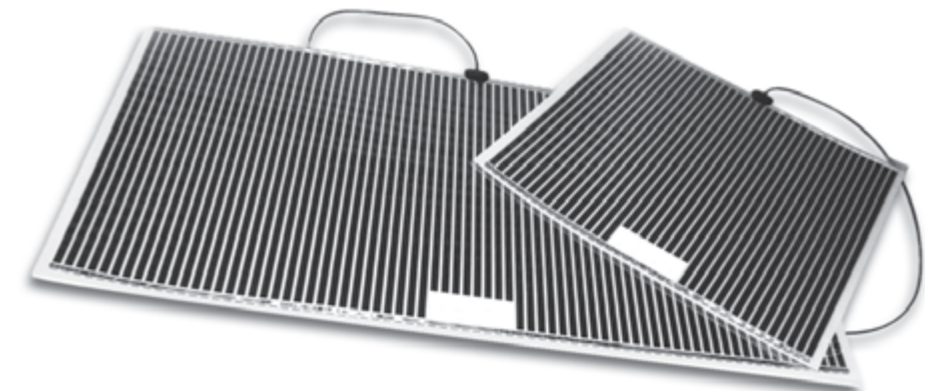

AquaDrill Pro BO 79.304



Aqua Drill Pro – small but impressively strong, which makes wet drilling as easy as can be. Experienced users know what happens if something goes wrong while drilling tiles or granite plates: frustration, loss of time, additional costs. This can all be avoided with the right equipment.

Aqua Drill Pro offers three distinct advantages for drilling the hardest material quickly and break-proof.

1. Optimum cooling

The continuous water supply and drainage enables optimum cooling to keep temperatures as low as possible and achieve best drilling results.

2. Low contact pressure

The special diamond hollow drills enable maximum abrasion while drilling and thus reduce the contact pressure.

3. Drilling aid templates

Three different drilling aid templates are available to choose from. They ensure full control when applying the drill – without undesired movements.

Aqua Drill Pro Product Selector

Drilling Aid Template Art. No. BO 79.350

The drilling aid template with water supply / water collection drain enables precise drilling with minimal contamination of the surrounding area. The drilling dust is discharged with the cooling water from the sealed dirt chamber via the drain hose (sealed to the tile and the drill). Optimum cooling for unbreakable drilling. Permanent water supply and drainage. Interchangeable drill brushes for diameters 6, 8, 10 and 12mm.



Water Pressure Tank 12l Art. No. BO 79.370

The mobile water pressure tank enables a mains-independent water supply for machines with diamond tools and can be used in the stone, sanitary and glass sectors. The integrated manometer enables constant pressure monitoring. Independent water supply.



- 1 High quality Bohle water feed chuck
- 2 Four switchable speeds
- 3 Adjustable torque control
- 4 Universal drill connection 1/2"
- 5 Ergonomic handle
- 6 Fast coupling for water intake
- 7 Powerful Lithium-ion battery, 18 V/6 Ah

Included in delivery:

- 1 Piece FEIN cordless drill/driver
- 1 Piece High-quality Bohle water feed chuck
- 1 Piece Powerful lithium-ion battery 18V / 6 Ah
- 1 Piece Spare battery 18V / 6 Ah
- 1 Piece Charger
- 1 Piece Quick coupling for water supply
- 1 Piece Bit chuck
- 1 Piece Quick-action drill chuck
- 1 Piece Toolbox

BriteGuard® Pro

Glass Cleaner & Mirror Adhesive



BriteGuard® Pro is a transparent coating for all smooth glass and glazed ceramic surfaces which offers quick and long-lasting protection against corrosion. It creates an easy-to-clean surface which makes it hard for dirt particles to adhere to it.

Product Highlights:

- For glass showers, windows, conservatories – any smooth glass surface
- Fast and easy application
- Durable protection
- Cost effective
- No special pre-cleaner required



BO 585055



BO 5855000

BriteGuard® Pro Surface Protection

Art. No.	Description
BO 5850101	BriteGuard® Pro surface protector, 100ml
BO 5850500	BriteGuard® Pro surface protector, 500ml
BO 5855000	BriteGuard® Pro surface protector, 5l
BO 5881001	BriteGuard® limescale remover, 1l
BO 5885001	BriteGuard® limescale remover, 5l
BO 5820500	BriteGuard® surface sealer X, 500ml
BO 5825000	BriteGuard® surface sealer X, 5l

Glass Cleaner

Art. No.	Description
BO 5107900	Bohle professional glass cleaner, box of 12 cans
BO 6023107	Bohle professional glass cleaner, trigger spray, 6 bottles

Xtragrip® Mirror Adhesive

Xtragrip® Silicone is suitable for tension-balancing bonding of mirrors according to DIN EN 1036 on all common building substrates. The one-component adhesive is neutral, solvent-free and permanently elastic. Pre-treat porous substrates with an adhesion promoter. Use up quickly after opening.

Xtragrip®

Art. No.	Description
BO 6002005	Silicone
BO 5730006	MS Polymer

Soudal Primer

Soudal Primer Art. No. BO 6002006

Soudal Primer 150 improves the adhesion of silicones and MS polymers on porous substrates. It is mainly used for the assembly of mirrors with Xtragrip® mirror adhesive and Xtragrip® MS polymer. Its use is also recommended in cases of increased humidity.



BO 5107900



BO 6002005



BO 6002006

Bohle Ltd.
Fifth Avenue
Tameside Park, Dukinfield
Cheshire SK16 4PP

T +44 161 3421100
F +44 161 3440111

info@bohle.ltd.uk
www.bohle.com